







赣工机械设备科技（东莞）有限公司

网址：www.lusimin.com

电话：15920631511

GGM1-M7

型号									
	功率/HP	工作气压/Mpa	耗气量m ³ /min	转速RPM/min	额定扭矩/N,m	最大扭矩/N,m	基本式	立式	卧式
GGM1	1/8	0.3-0.7	0.18	1200	0.64	1.1	1.4	1.7	2.2
GGM2	1/6		0.2	1100	0.84	1.57	2.1	2.3	2.8
GGM3	1/4		0.26	900	1.7	2.3	2.7	3.1	3.6
GGM4	1/3		0.3	800	3.5	3.92	3.3	3.7	4.2
GGM5	1/2		0.395	750	4.7	6.5	5.0	5.5	6.5
GGM6	3/4		0.54	650	7.6	11.5	5.8	6.5	7.8
GGM7	1.5		0.99	360	28	45.8	23		29

GGM7

轴
Axis

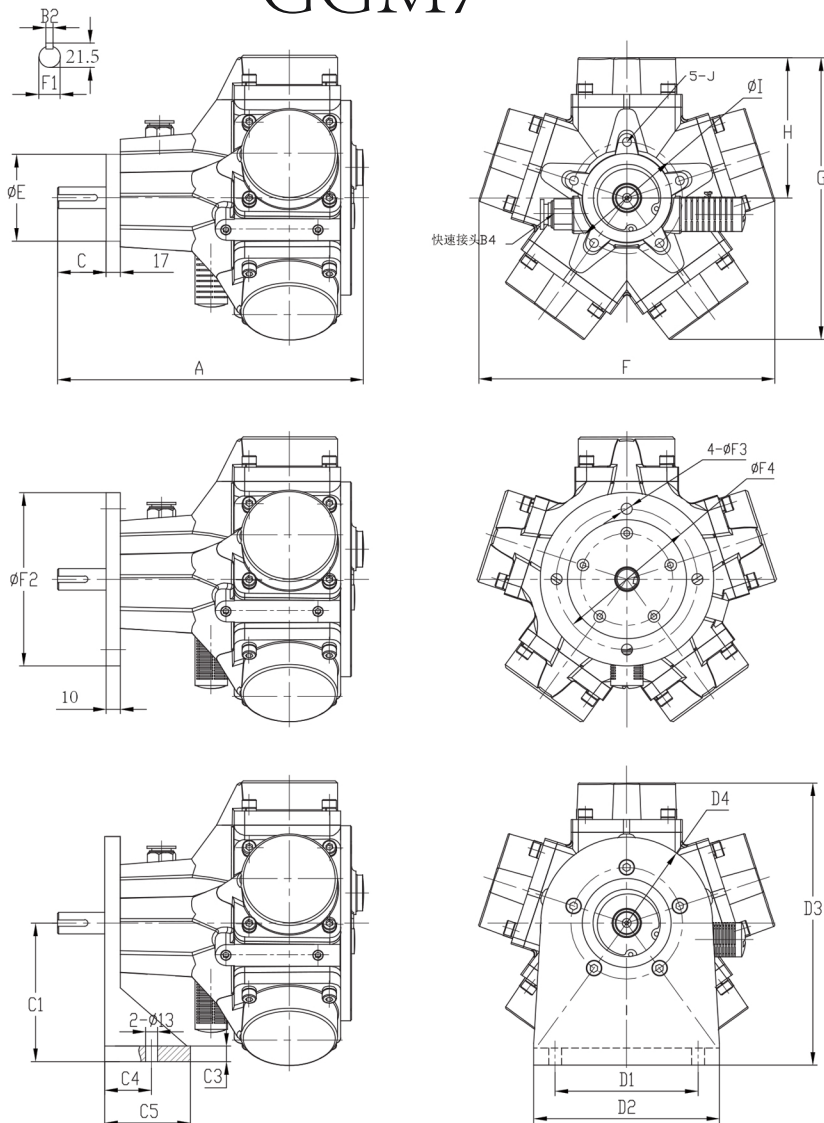

A	C	E	F	G	H	I	J	A1	F4	F2	F3	C1	C3	C4	C5	D1	D2	D3	D4	F1	B1	B2	B3	B4
300	75	80	267	263	132	100	M8	70	165	190	10	135	16	60	115	150	195	268	R70	19	24	6	50	G-1/2